

TCD142 SERIES LUMINAIRE

U.11.14.18

DESCRIPTION

The contemporary styled TCD142 Series combines a cast aluminum housing, a spun aluminum shade and a choice of optical systems to create an efficient luminaire with several light distributions.

HID ELECTRICAL

- High power factor ballast (HPF), core and coil type, pre-wired and tested
- 4KV porcelain socket

ETL listed, suitable for wet locations.

INSTALLATION

The luminaire and crook will mount to a 4" OD post or tenon with 5/16" black oxide coated stainless steel set screws to ensure a solid connection.

OPTICAL SYSTEMS

HR3 -Type III segmented reflector with a clear glass lens.

HR5 -Type V segmented reflector with a clear glass lens.

FINISH:

Durable thermoset polyester powdercoat finish in the following:

- Satin Black (**BLK**)
- Classic Bronze (**CLB**)
- Gloss Textured Bronze (**GBZ**)
- Green (**GRN**)
- Gloss Textured Black (**GTB**)
- Textured Black (**TBK**)
- Gloss Textured Green (**TGR**)



With PA lens



With HR-GL

TCD142 SERIES HID



PROJECT:

LOCATION:

FIXTURE TYPE:

NOTES:

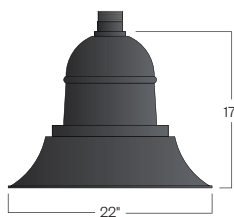

TCD142-FS22
EPA: 1.14

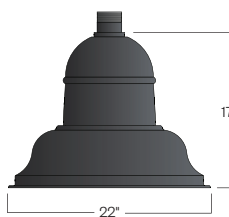

TCD142-RFS22
EPA: 1.2

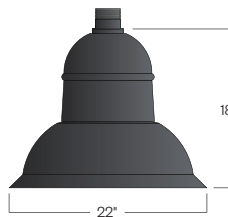

TCD142-SDS22
EPA: 1.26

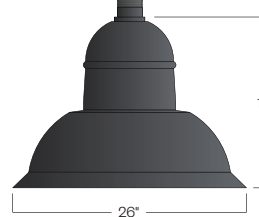

TCD142-SDS26
EPA: 1.52



TCD142 SERIES LUMINAIRE

TCD142 SERIES
HID

Ordering Information

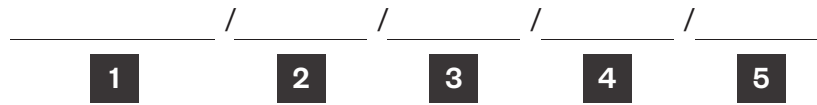

- | | |
|--|--|
| 1 <u>Model</u>
TCD142-FS22
TCD142-RFS22
TCD142-SDS22 | 4 <u>Voltage</u>
120V
208V
240V
277V |
| 2 <u>Optical System</u>
HR3 - Type 3 Reflector
HR5 - Type 5 Reflector | 5 <u>Finish</u>
BLK - Satin Black
CLB - Classic Bronze
GBZ - Gloss Textured Bronze
GRN - Green
GTB - Gloss Textured Black
TBK - Textured Black
TGR - Gloss Textured Green
CSTM - Custom |
| 3 <u>Light Source</u>
70MH - 70w Metal Halide
100MH - 100w Metal Halide
150MH - 150w Metal Halide
70HPS - 70w High Pressure Sodium
100HPS - 100w High Pressure Sodium
150HPS - 150w High Pressure Sodium
MDO - Medium Socket Only
MGO - Mogul Socket Only | |

Mounting Ordering Information

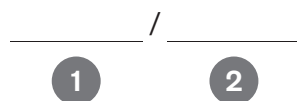

- | | |
|--|--|
| 1 <u>Model</u>
TCBR01-1-24
TCBR01-1-36
TCBR40-1-24-L
TCBR40-2-24-L
TCBR81-1-30
TCBR81-2-30
TPT40
TPT41R PT42R | 2 <u>Finish</u>
BLK - Satin Black
CLB - Classic Bronze
GBZ - Gloss Textured Bronze
GRN - Green
GTB - Gloss Textured Black
TBK - Textured Black
TGR - Gloss Textured Green
CSTM - Custom |
|--|--|

Assembly Details
(Example: PT40/D142-RFS22/HR5-GL)

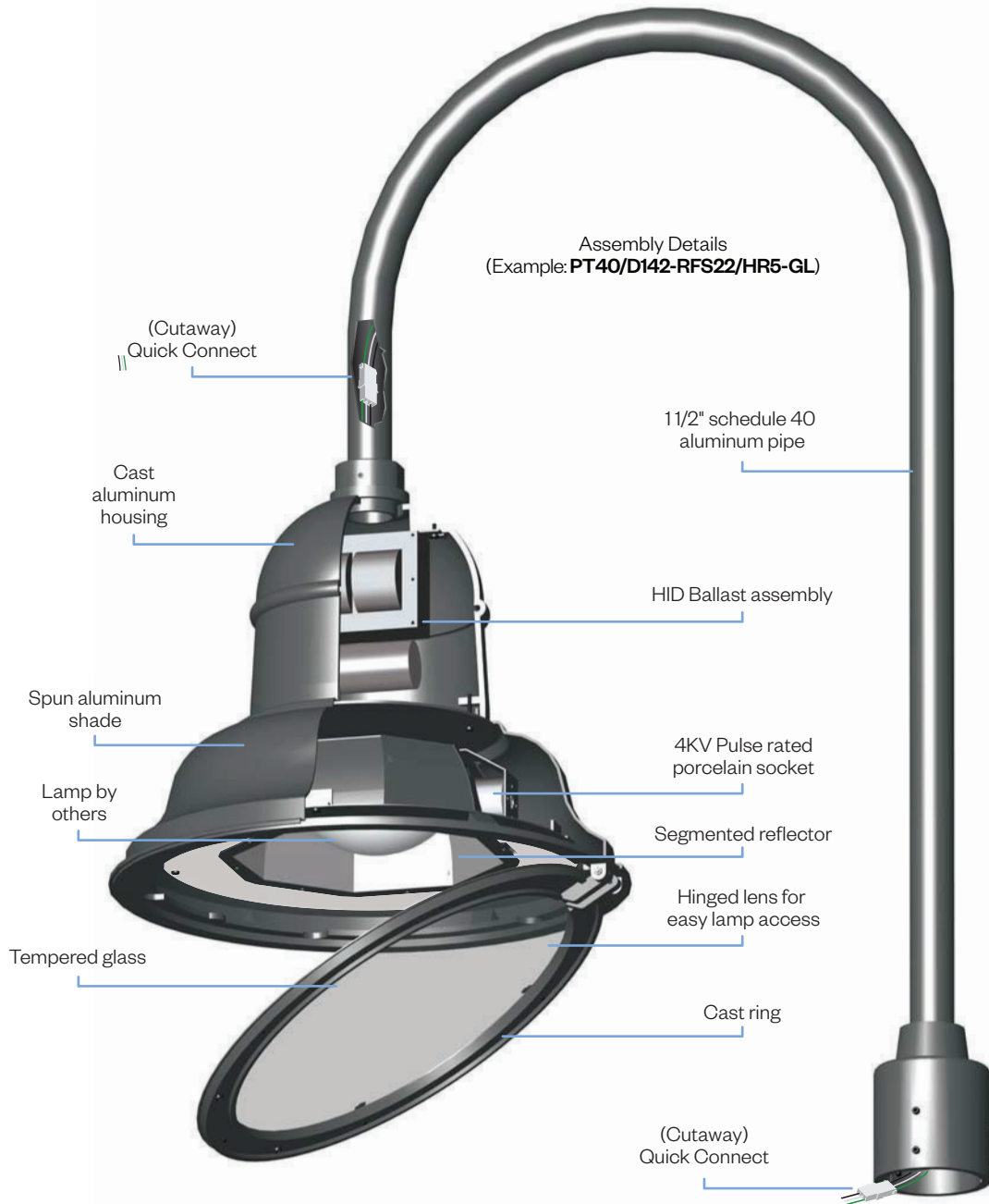

Standard Photometry

D142-RFS22/HR5
Typical HID light source
14,000 Lumen
12' Mounting Height
Grid Spacing is 12'

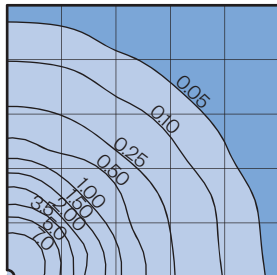

Socket Types

Wattage	Socket Size
70MH;100MH;150MH	Medium
70HPS;100HPS	Medium
150HPS	Mogul

Mounting Options

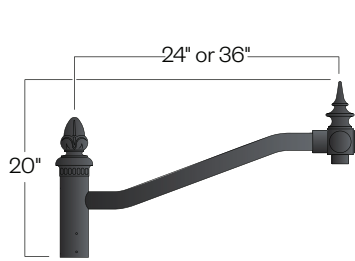

TCBR01-1-36 or TCBR01-1-24

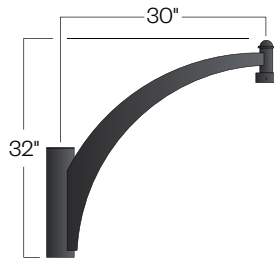

TCBR81-1-30

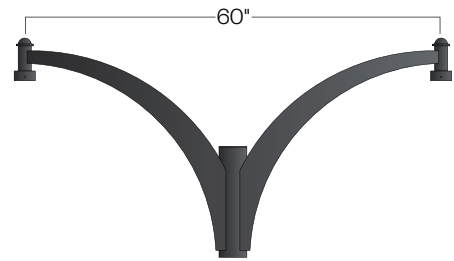

TCBR81-2-30

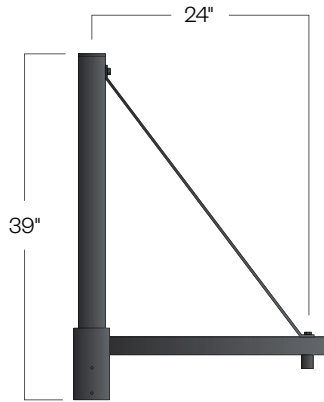

TCBR40-1-24-L

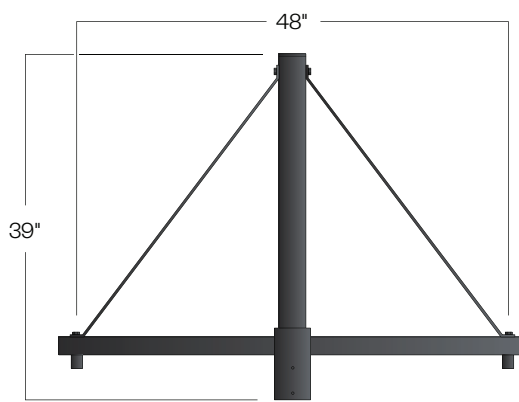

TCBR40-2-24-L

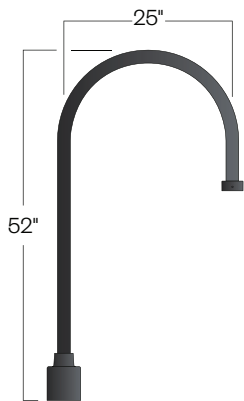

TPT40

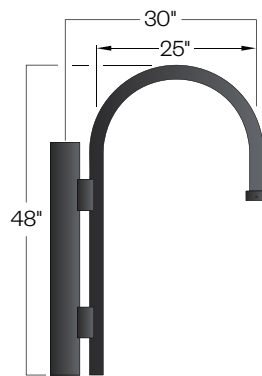

TPT41R

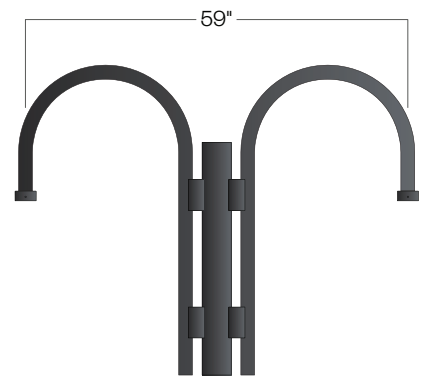

TPT42R